

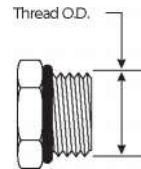

HOSE
HOSE/CPLG. SELECTION
G8K COUPLINGS
GLOBAL SPIRAL COUPLINGS
PCM / PCS FERRULES
MEGACRIMP COUPLINGS
STAINLESS STEEL
POWER CRIMP COUPLINGS
LOC, GL AND GLP COUPLINGS
POLARSEAL COUPLINGS
POLARSEAL II COUPLINGS
C14 COUPLINGS
PCTS THERMOPLASTIC COUPLINGS
FIELD ATTACHABLE G1 & G2 COUPLINGS
FIELD ATTACHABLE C5 & C5E COUPLINGS
SURELOK AIR BRAKE COUPLINGS
ADAPTERS
QUICK DISCONNECT COUPLERS
LIVE SWIVEL
BALL VALVES
ACCESSORIES
EQUIPMENT AND PARTS

Male O-Ring Boss

SAE J1926/3 ISO 11926-3 Light-Duty (L Series) Stud End.

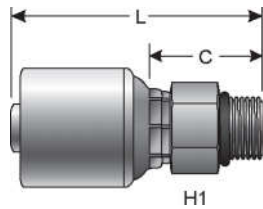

Descr.	Prod. No.	⌀			H1	L		C		Weight (Lbs.)
		"	mm	"	"	"	mm	"	mm	
4G-4MB	7100-12205	1/4	6.4	7/16-20	9/16	1.99	50.5	.96	24.5	.13
4G-5MB	7100-12215	1/4	6.4	1/2-20	5/8	1.99	50.5	.96	24.5	.13
4G-6MB	7100-12225	1/4	6.4	9/16-18	11/16	2.05	52.0	1.02	26.0	.16
6G-5MB	7100-12285	3/8	9.5	1/2-20	5/8	2.05	52.0	.95	24.1	.15
6G-6MB	7100-13235	3/8	9.5	9/16-18	11/16	2.20	56.0	1.11	28.1	.15
6G-8MB	7100-13245	3/8	9.5	3/4-16	7/8	2.28	58.0	1.19	30.1	.31
6G-10MB	7100-12255	3/8	9.5	7/8-14	1	2.22	56.5	1.13	28.6	.26
6G-12MB	7100-12265	3/8	9.5	1 1/16-12	1 1/4	2.42	61.5	1.32	33.6	.26
8G-8MB	7100-13275	1/2	12.7	3/4-16	7/8	2.64	67.0	1.16	29.5	.30
8G-10MB	7100-13285	1/2	12.7	7/8-14	1	2.68	68.0	1.20	30.5	.35
8G-12MB	7100-13295	1/2	12.7	1 1/16-12	1 1/4	2.91	74.0	1.44	36.5	.50
10G-8MB	7100-02305	5/8	15.9	3/4-16	15/16	2.83	72.0	1.36	34.5	.37
10G-10MB	7100-13315	5/8	15.9	7/8-14	1	2.83	72.0	1.36	34.5	.40
10G-12MB	7100-13325	5/8	15.9	1 1/16-12	1 1/4	2.99	76.0	1.52	38.5	.55
12G-10MB	7100-02265	3/4	19.1	7/8-14	1	3.23	82.1	1.22	31.1	.55
12G-12MB	7100-02335	3/4	19.1	1 1/16-12	1 1/4	3.33	84.5	1.32	33.5	.60
12G-14MB	7100-02345	3/4	19.1	1 3/16-12	1 3/8	3.31	84.0	1.30	33.0	.68
12G-16MB	7100-02355	3/4	19.1	1 5/16-12	1 1/2	3.44	87.5	1.44	36.5	.68
16G-14MB	7100-02365	1	25.4	1 3/16-12	1 3/8	3.78	96.0	1.54	39.2	.97
16G-16MB	7100-02375	1	25.4	1 5/16-12	1 1/2	3.84	97.5	1.60	40.7	1.08
16G-20MB	7100-02255	1	25.4	1 5/8-12	1 7/8	3.74	95.0	1.50	38.2	1.35
20G-20MB	7100-02385	1 1/4	31.8	1 5/8-12	1 7/8	3.90	99.0	1.57	40.0	1.48

Male O-Ring Boss Swivel

NOT TO BE USED AS A LIVE SWIVEL.
 NOTE: Internal O-Rings rated at 250°F (121°C).
 SAE J1926/3 ISO 11926-3 Light-Duty (L Series) Stud End.

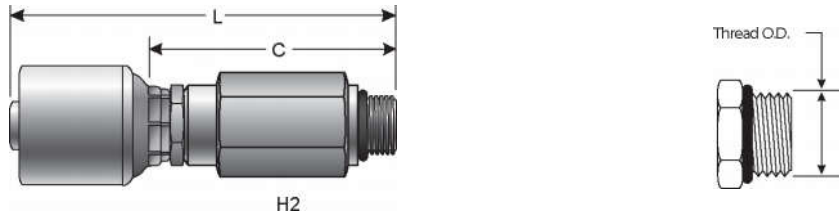

Descr.	Prod. No.	⊖			H2	L		C		Weight (Lbs.)
		"	mm	"	mm	"	mm	"	mm	
4G-4MBX	7209-40015	1/4	6.4	7/16-20	19	3.21	81.5	2.19	55.5	.27
4G-6MBX	7209-40025	1/4	6.4	9/16-18	19	3.21	81.5	2.19	55.5	.28
6G-6MBX	7209-40045	3/8	9.5	9/16-18	22	3.33	84.5	2.23	56.6	.35
6G-8MBX	7209-40055	3/8	9.5	3/4-16	23	3.33	84.5	2.23	56.6	.40
6G-10MBX	7209-40065	3/8	9.5	7/8-14	27	3.21	81.5	2.11	53.6	.44
8G-8MBX	7209-40085	1/2	12.7	3/4-16	23	3.78	96.0	2.30	58.5	.50
8G-10MBX	7209-40095	1/2	12.7	7/8-14	27	3.84	97.5	2.36	60.0	.49
10G-10MBX	7209-40115	5/8	15.9	7/8-14	32	3.88	98.5	2.40	61.0	.53
12G-12MBX	7209-40145	3/4	19.1	1 1/16-12	32	4.55	115.5	2.54	64.5	.92

Male O-Ring Boss Swivel - 45° Bent Tube

NOT TO BE USED AS A LIVE SWIVEL.
 NOTE: Internal O-Rings rated at 250°F (121°C).
 SAE J1926/3 ISO 11926-3 Light-Duty (L Series) Stud End.

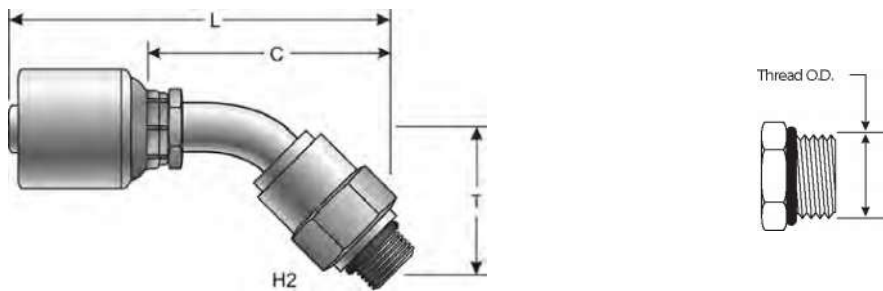

Descr.	Prod. No.	⊖			H2	T		L		C		Weight (Lbs.)
		"	mm	"	mm	"	mm	"	mm	"	mm	
6G-6MBX45	7209-40225	3/8	9.5	9/16-18	22	1.52	38.7	3.65	92.6	2.54	64.6	.35
6G-8MBX45	7209-40235	3/8	9.5	3/4-16	24	1.52	38.7	3.65	92.6	2.54	64.6	.42
8G-8MBX45	7209-40255	1/2	12.7	3/4-16	24	1.64	41.7	4.24	107.7	2.77	70.3	.52
8G-10MBX45	7209-40265	1/2	12.7	7/8-14	27	1.69	42.8	4.28	108.8	2.81	71.3	.61

HOSE
HOSE/CPLG. SELECTION
G8K COUPLINGS
GLOBALSPIRAL COUPLINGS
PCM / PCS FERRULES
MEGACRIMP COUPLINGS
STAINLESS STEEL
POWER CRIMP COUPLINGS
LOC, GL AND GLP COUPLINGS
POLARSEAL COUPLINGS
POLARSEAL II COUPLINGS
C14 COUPLINGS
PCTS THERMOPLASTIC COUPLINGS
FIELD ATTACHABLE G1 & G2 COUPLINGS
FIELD ATTACHABLE C5 & C5E COUPLINGS
SURELOK AIR BRAKE COUPLINGS
ADAPTERS
QUICK DISCONNECT COUPLERS
LIVE SWIVEL
BALL VALVES
ACCESSORIES
EQUIPMENT AND PARTS

Male O-Ring Boss Swivel - 45° Block

NOT TO BE USED AS A LIVE SWIVEL.
 NOTE: Internal O-Rings rated at 250°F (121°C).
 SAE J1926/3 ISO 11926-3 Light-Duty (L Series) Stud End.

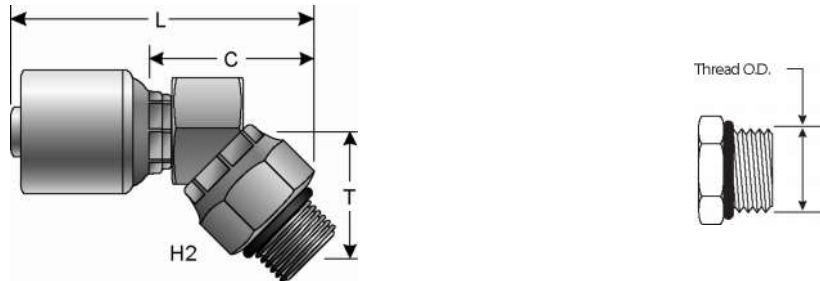

Descr.	Prod. No.	⊖		H2	T		L		C		Weight (Lbs.)	
		"	mm		"	mm	"	mm	"	mm		
6G-6MBX45BL	7100-12475	3/8	9.5	9/16-18	7/8	1.09	27.8	3.11	79.0	2.01	51.0	.33
6G-8MBX45BL	7100-12485	3/8	9.5	3/4-16	1	1.06	26.9	3.07	78.1	1.98	50.2	.39
8G-8MBX45BL	7100-02495	1/2	12.7	3/4-16	1	1.12	28.4	3.04	77.2	1.56	39.7	.44
8G-10MBX45BL	7100-02505	1/2	12.7	7/8-14	1	1.16	29.5	3.08	78.3	1.61	40.8	.46

Male O-Ring Boss Swivel - 90° Bent Tube

NOT TO BE USED AS A LIVE SWIVEL.
 NOTE: Internal O-Rings rated at 250°F (121°C).
 SAE J1926/3 ISO 11926-3 Light-Duty (L Series) Stud End.

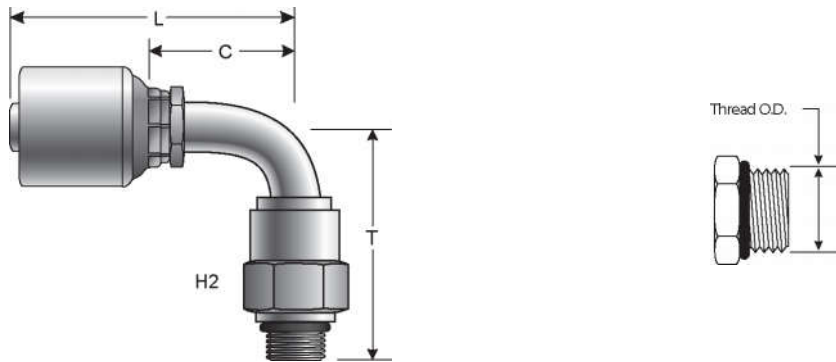

Descr.	Prod. No.	⊖		H2	T		L		C		Weight (Lbs.)	
		"	mm		"	mm	"	mm	"	mm		
4G-6MBX90	7209-40425	1/4	6.4	9/16-18	7/8	2.36	60.0	2.19	55.6	1.17	29.6	.29
6G-6MBX90	7209-40455	3/8	9.5	9/16-18	7/8	2.48	63.1	2.47	62.8	1.37	34.8	.40
6G-8MBX90	7209-40475	3/8	9.5	3/4-16	1	2.48	63.1	2.47	62.8	1.37	34.8	.45
6G-10MBX90	7209-40485	3/8	9.5	7/8-14	1	2.37	60.1	2.47	62.8	1.37	34.8	.47
8G-8MBX90	7209-40505	1/2	12.7	3/4-16	1	2.76	70.1	3.16	80.3	1.69	42.9	.56
8G-10MBX90	7209-40525	1/2	12.7	7/8-14	1	2.82	71.6	3.16	80.3	1.69	42.9	.59
8G-12MBX90	7209-40545	1/2	12.7	1 1/16-12	1 1/4	2.90	73.6	3.16	80.3	1.69	42.9	.80
10G-10MBX90	7209-40585	5/8	15.9	7/8-14	1 5/16	3.14	79.8	3.55	90.1	2.07	52.6	.68
10G-12MBX90	7209-40605	5/8	15.9	1 1/16-12	1	3.18	80.8	3.55	90.1	2.07	52.6	.86
12G-12MBX90	7209-40645	3/4	19.1	1 1/16-12	1 5/16	3.42	86.8	4.33	110.1	2.33	59.1	1.05

Male O-Ring Boss Swivel - 90° Block

NOT TO BE USED AS A LIVE SWIVEL.
 NOTE: Internal O-Rings rated at 250°F (121°C).
 SAE J1926/3 ISO 11926-3 Light-Duty (L Series) Stud End.

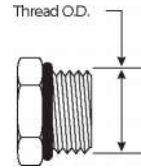
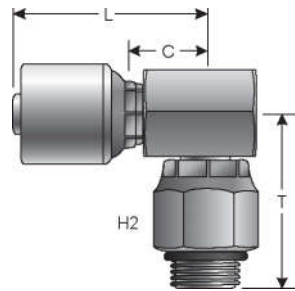

Descr.	Prod. No.	⊖		🌀	H2	T		L		C		Weight (Lbs.)
		"	mm			"	mm	"	mm	"	mm	
4G-5MBX90BL	7100-12555	1/4	6.4	1/2-20	11/16	1.57	40.0	1.75	44.4	.80	20.2	.20
4G-6MBX90BL	7100-12515	1/4	6.4	9/16-18	7/8	1.65	41.8	1.82	46.3	.80	20.2	.33
6G-10MBX90BL	7100-12545	3/8	9.5	7/8-14	1	1.69	42.8	1.95	49.6	.85	21.7	.40
8G-8MBX90BLL	7100-02705	1/2	12.7	3/4-16	1	1.75	44.4	3.27	83.1	1.80	45.6	.78
8G-10MBX90BL	7100-02565	1/2	12.7	7/8-14	1	1.81	46.0	2.55	64.7	1.07	27.2	.59
8G-10MBX90BLL	7100-02715	1/2	12.7	7/8-14	1	1.81	46.0	3.27	83.1	1.80	45.6	.80
8G-12MBX90BL	7100-02575	1/2	12.7	1 1/16-12	1 5/16	2.09	53.1	2.52	64.1	1.07	27.2	.82
8G-12MBX90BLL	7100-02725	1/2	12.7	1 1/16-12	1 5/16	2.09	53.1	3.76	95.5	2.28	58.0	1.10
10G-10MBX90BLL	7100-02735	5/8	15.9	7/8-14	1	1.81	46.0	3.15	79.9	1.67	42.4	.79
12G-12MBX90BLL	7100-02755	3/4	19.1	1 1/16-12	1 5/16	2.28	57.9	3.94	100.0	1.93	49.0	1.54

HOSE
HOSE/CPLG. SELECTION
G8K COUPLINGS
GLOBALSPIRAL COUPLINGS
PCM / PCS FERRULES
MEGACRIMP COUPLINGS
STAINLESS STEEL
POWER CRIMP COUPLINGS
LOC, GL AND GLP COUPLINGS
POLARSEAL COUPLINGS
POLARSEAL II COUPLINGS
C14 COUPLINGS
PCTS THERMOPLASTIC COUPLINGS
FIELD ATTACHABLE G1 & G2 COUPLINGS
FIELD ATTACHABLE C5 & C5E COUPLINGS
SURELOK AIR BRAKE COUPLINGS
ADAPTERS
QUICK DISCONNECT COUPLERS
LIVE SWIVEL
BALL VALVES
ACCESSORIES
EQUIPMENT AND PARTS